

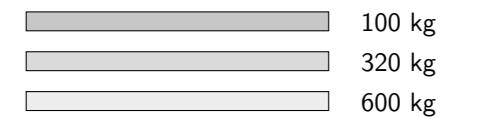

Description		Scale
Working area (theoretical) <b>RUTHMANNSTEIGER® T 295 A</b> Kenworth T800		1:900
		Com. No. 32780
Ruthmann Gmbh & Co. KG Ruthmannstr. 4 48712 Gescher Germany	 <b>RUTHMANN</b> professionals at work	Sheet 1
		No. Sheets 2
Date: 15th January 2021	Format: A3	FTA-hem

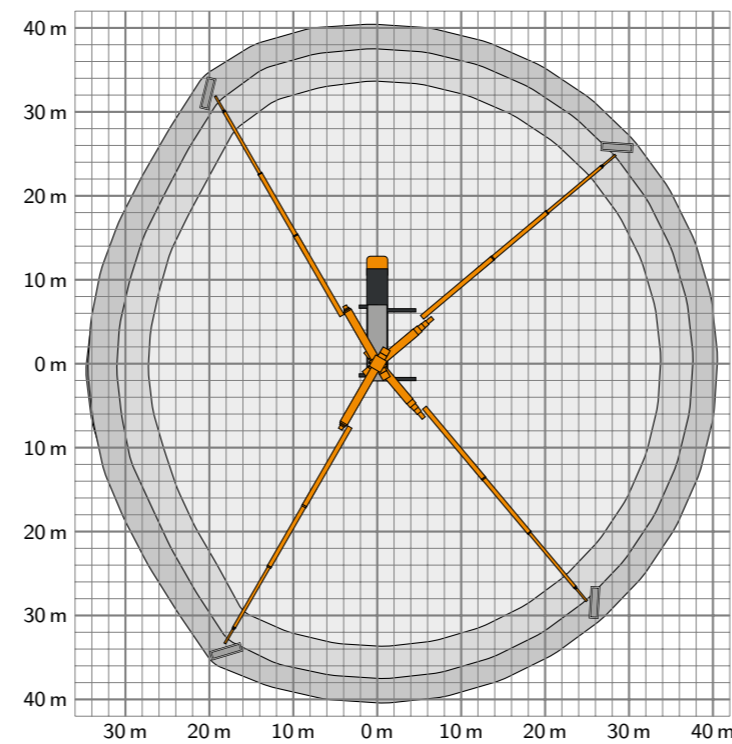
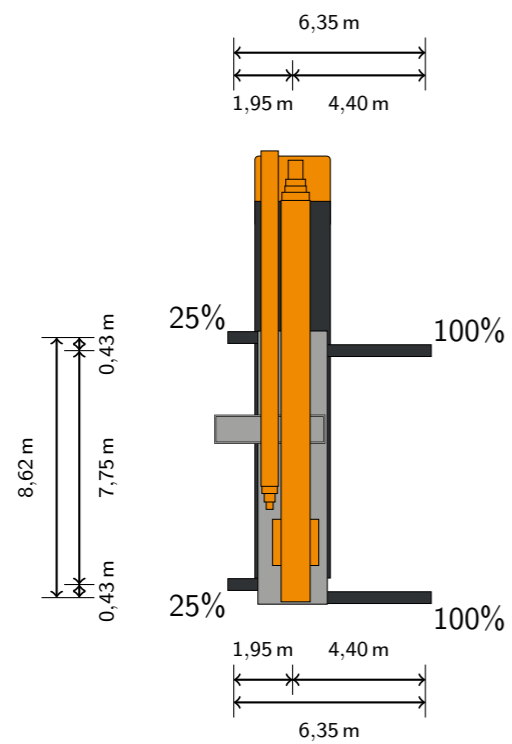
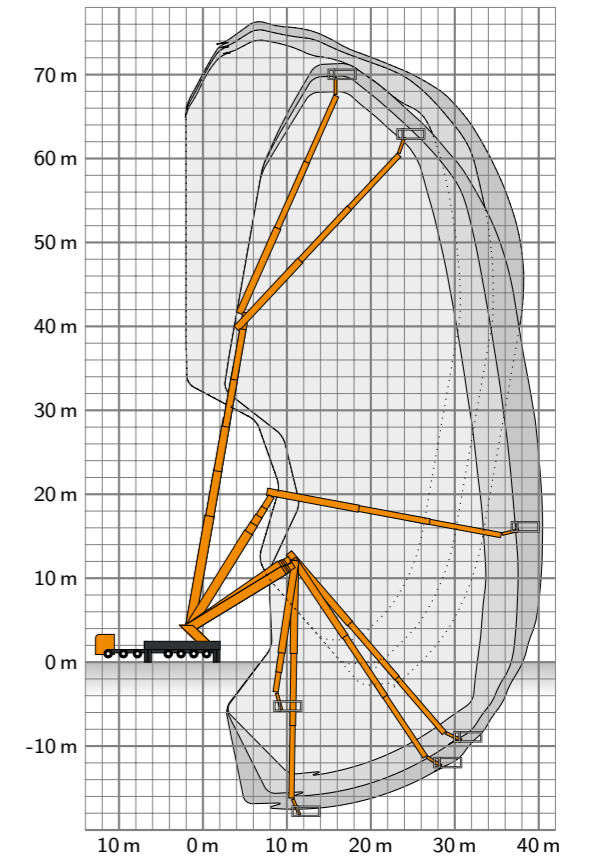
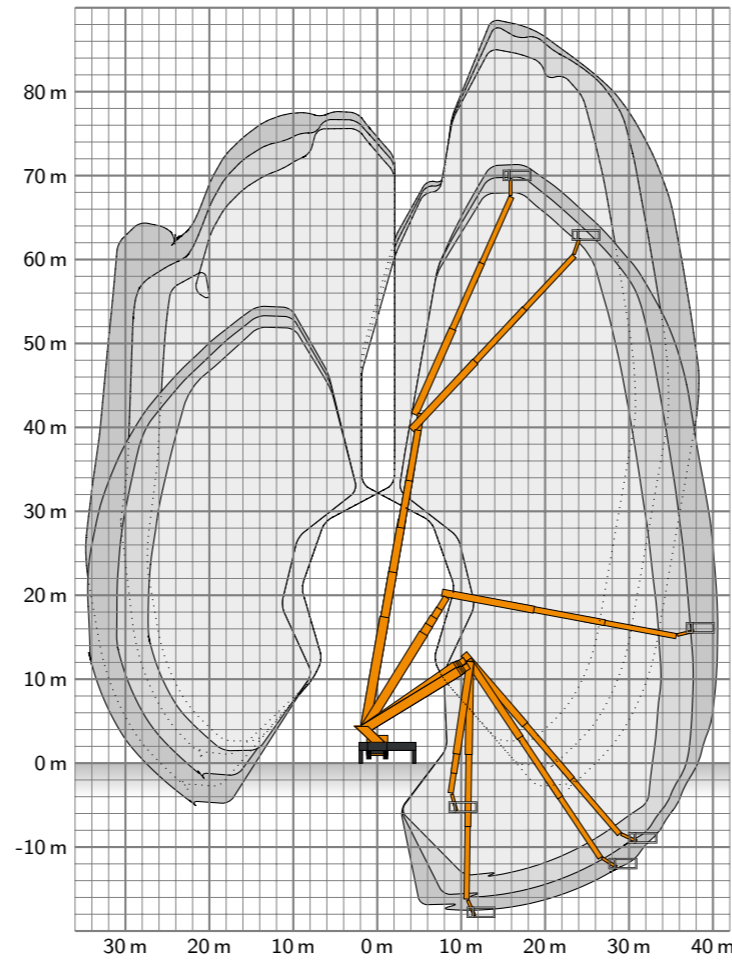
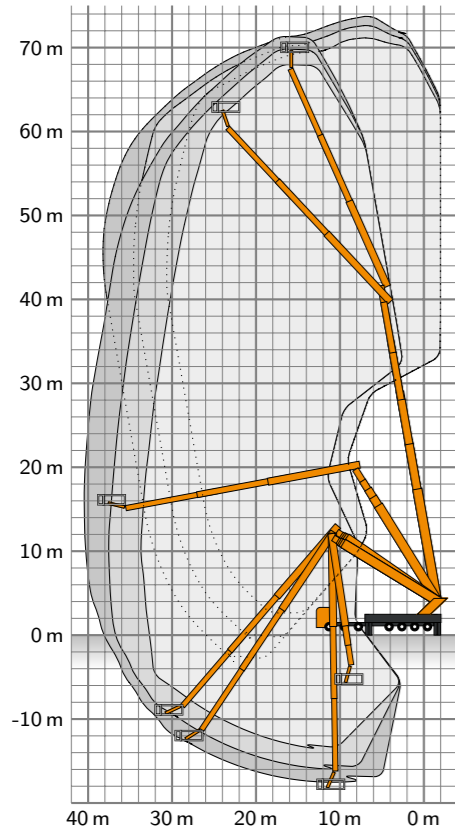

Description		Scale
Working area (theoretical) <b>RUTHMANNSTEIGER® T 295 A</b> Kenworth T800		1:900
		Com. No. 32780
Ruthmann Gmbh & Co. KG Ruthmannstr. 4 48712 Gescher Germany	 <b>RUTHMANN</b> professionals at work	Sheet 2
		No. Sheets 2
Date: 15th January 2021	Format: A3	FTA-hem